

ST 050 203 2979



Compatibile con: IMO, LISSÉ, META

- asta da parete con supporto scorrevole
- Diametro del tubo 18 mm
- interasse 853 mm
- Flessibile doccetta in metallo 1750mm con protezione antitorsione integrata
- Attacco tubo doccia 3/8"
- A tre o regolazioni: COMPACT RAIN, COMPACT SOFT FLOW, COMPACT AQUAPRESSURE FLOW, portata max. 6,8 l/min (a 3 bar)
- Funzione a partire da: 6 l/min
- Soffione Ø 100mm
- Questo prodotto può aiutare un edificio a soddisfare i requisiti dei Green Building Rating Systems, ad es. LEED®, BREEAM®, DGNB

	Cromato	ST 050 203 2979-00 0010
	Cromato	ST 050 203 9979-00
	Platinato spazzolato	ST 050 203 9979-06
	Platinato spazzolato	ST 050 203 2979-06 0010
	Platinato	ST 050 203 9979-08
	Platinato	ST 050 203 2979-08 0010
	Dark Chrome	ST 050 203 9979-19
	Dark Chrome	ST 050 203 2979-19 0010
	Light Gold	ST 050 203 9979-26
	Light Gold	ST 050 203 2979-26 0010
	Light Gold spazzolato	ST 050 203 9979-27
	Light Gold spazzolato	ST 050 203 2979-27 0010
	Ottone spazzolato (Oro 23k)	ST 050 203 9979-28
	Ottone spazzolato (Oro 23k)	ST 050 203 2979-28 0010
	Nero opaco	ST 050 203 9979-33
	Nero opaco	ST 050 203 2979-33 0010
	Bronzo spazzolato	ST 050 203 9979-42
	Bronzo spazzolato	ST 050 203 2979-42 0010
	Champagne spazzolato (Oro 22k)	ST 050 203 9979-46
	Champagne spazzolato (Oro 22k)	ST 050 203 2979-46 0010
	Champagne (Oro 22k)	ST 050 203 9979-47
	Champagne (Oro 22k)	ST 050 203 2979-47 0010
	Cromo spazzolato	ST 050 203 9979-93
	Cromo spazzolato	ST 050 203 2979-93 0010
	Dark Platinum spazzolato	ST 050 203 9979-99
	Dark Platinum spazzolato	ST 050 203 2979-99 0010

ST 050 203 2979

Componenti singoli di questo set

Per questo set sono necessari i seguenti componenti



1x 26 413 979-00



1x 28 018 979-00 0010

ST 050 203 2979



Compatibile con: IMO, LULU, MEM, TARA,
CL.1, LISSÉ, VAIA, META, CYO

- asta da parete con supporto scorrevole
- Diametro del tubo 18 mm
- interasse 853 mm
- Flessibile doccetta in metallo 1750mm con protezione antitorsione integrata
- Attacco tubo doccia 3/8"

Questo articolo non include la doccetta!

	Cromato	26 413 979-00
	Platinato spazzolato	26 413 979-06
	Platinato	26 413 979-08
	Dark Chrome	26 413 979-19
	Light Gold	26 413 979-26
	Light Gold spazzolato	26 413 979-27
	Ottone spazzolato (Oro 23k)	26 413 979-28
	Nero opaco	26 413 979-33
	Bronzo spazzolato	26 413 979-42
	Champagne spazzolato (Oro 22k)	26 413 979-46
	Champagne (Oro 22k)	26 413 979-47
	Cromo spazzolato	26 413 979-93
	Dark Platinum spazzolato	26 413 979-99

ST 050 203 2979

Prodotti complementari

	raccordo angolare ad incasso - 35 085 970 90 ●Profondità d'incasso max. 163 mm ●profondità d'incasso min. 90 mm
---	--

Prodotti complementari

	LISSE Raccordo curvo - Cromato 28 450 845-00
---	---

Prodotti complementari necessari

	Doccetta - Cromato 28 016 979-00 ●portata max. 15 l/min (a 3 bar)
---	---

Prodotti complementari necessari

	Doccetta FlowReduce - Cromato 28 016 979-00 ●portata max. 6,8 l/min (a 3 bar) 0010
---	--

Prodotti complementari necessari

	Doccetta FlowReduce - Cromato 28 012 979-00 ●portata max. 6,8 l/min (a 3 bar) 0010
---	--

Prodotti complementari necessari

	Doccetta FlowReduce - Cromato 28 018 979-00 ●portata max. 6,8 l/min (a 3 bar) 0010
---	--

Prodotti complementari

	Raccordo curvo - Cromato 28 450 980-00
---	---

Prodotti complementari necessari

	Doccetta - Cromato 28 015 979-00 ●portata max. 15 l/min (a 3 bar)
---	---

Prodotti complementari necessari

	Doccetta - Cromato 28 012 979-00 ●portata max. 15 l/min (a 3 bar)
---	---

Prodotti complementari necessari

	Doccetta - Cromato 28 017 979-00 ●portata max. 15 l/min (a 3 bar)
---	---

Prodotti complementari necessari

	Doccetta - Cromato 28 018 979-00 ●portata max. 15 l/min (a 3 bar)
---	---

ST 050 203 2979

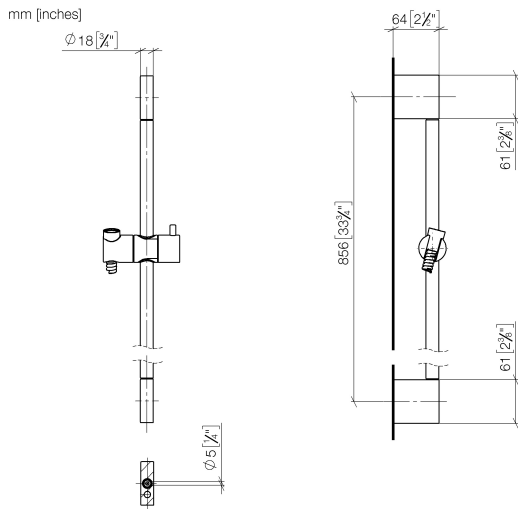

Certificati

WRAS_2009048. ACS_20 ACC LY 738. IAPMO_4976 (1).

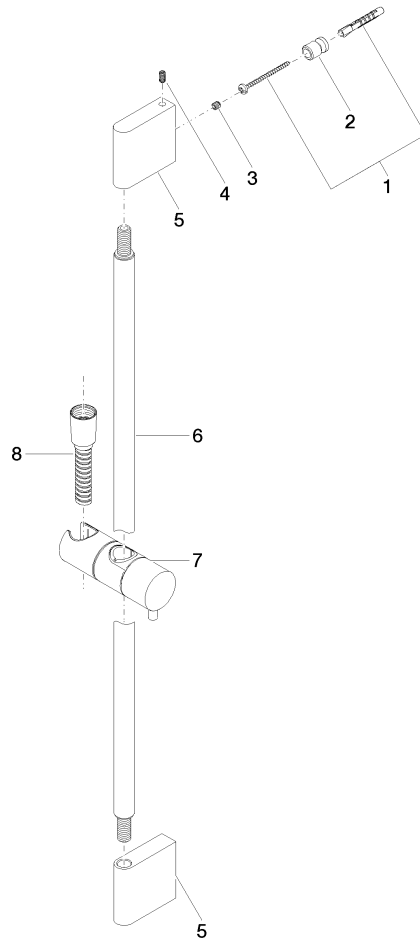

Elenco delle parti di ricambio

N.	Codice articolo	Denominazione	Quantità necessaria	Tempo di produzione
1	05 17 20 726 02 90	set di fissaggio	2	2
2	08 17 20 726 90	sostegno	2	2
3	09 31 11 049 90	perno	2	2
4	04 31 11 113 00 90	perno	2	2
5	08 17 97 054-00	sostegno	2	10
6	90 28 22 597 00-00	sostegno	1	10
7	12 580 970-00	Supporto scorrevole - Cromato	1	10
8	28 322 970-00	Flessibile metallico per doccia 1/2" x 3/8" x 1750 mm - Cromato	1	2

ST 050 203 2979



Compatibile con: IMO, LULU, MADISON, MEM, TARA, CL.1, LISSÉ, VAIA, META, CYO

- A tre o regolazioni: COMPACT RAIN, COMPACT SOFT FLOW, COMPACT AQUAPRESSURE FLOW, portata max. 6,8 l/min (a 3 bar)
- con sistema anticalcare
- Soffione Ø 100mm
- ingresso 1/2"
- Funzione a partire da: 6 l/min
- Questo prodotto può aiutare un edificio a soddisfare i requisiti dei Green Building Rating Systems, ad es. LEED®, BREEAM®, DGNB

Sistema di sicurezza antiriflusso.

	Cromato	28 018 979-00 0010
	Cromato	28 018 979-00
	Platinato spazzolato	28 018 979-06
	Platinato spazzolato	28 018 979-06 0010
	Platinato	28 018 979-08
	Platinato	28 018 979-08 0010
	Dark Brass matt	28 018 979-16 0010
	Dark Bronze matt	28 018 979-17 0010
	Dark Chrome	28 018 979-19
	Dark Chrome	28 018 979-19 0010
	Light Gold	28 018 979-26 0010
	Light Gold	28 018 979-26
	Light Gold spazzolato	28 018 979-27 0010
	Light Gold spazzolato	28 018 979-27
	Ottone spazzolato (Oro 23k)	28 018 979-28
	Ottone spazzolato (Oro 23k)	28 018 979-28 0010
	Nero opaco	28 018 979-33
	Nero opaco	28 018 979-33 0010
	Bronzo spazzolato	28 018 979-42
	Bronzo spazzolato	28 018 979-42 0010
	Champagne spazzolato (Oro 22k)	28 018 979-46
	Champagne spazzolato (Oro 22k)	28 018 979-46 0010
	Champagne (Oro 22k)	28 018 979-47
	Champagne (Oro 22k)	28 018 979-47 0010
	Cromo spazzolato	28 018 979-93
	Cromo spazzolato	28 018 979-93 0010
	Dark Platinum spazzolato	28 018 979-99
	Dark Platinum spazzolato	28 018 979-99 0010

ST 050 203 2979

mm [inches]



Diagramma di portata



Certificati

LGA_29984.

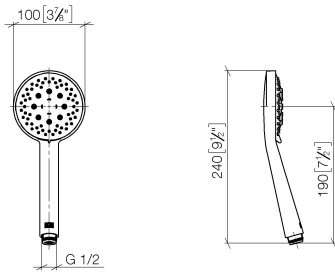
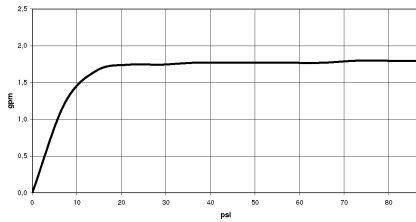
Elenco delle parti di ricambio

N.	Codice articolo	Denominazione	Quantità necessaria	Tempo di produzione
1	09 23 01 039 90	setaccio	1	2